

# ORDER INFORMATION

5 T 2 5 4 1 N - B

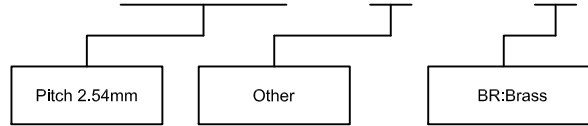

G 0 R Q 0 1

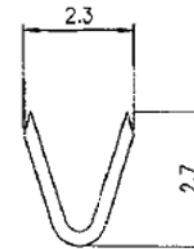
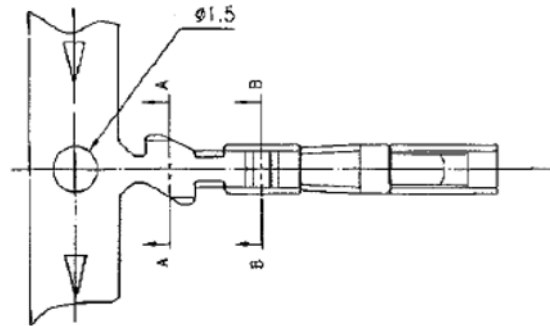
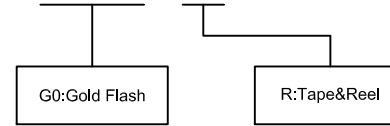

A-A SECTION

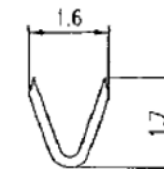
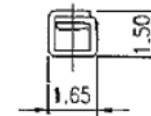
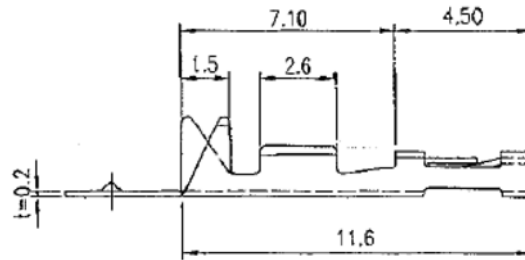

B-B SECTION

Wire Range	Insulation O.D.	Material	Finish	Qty/reel
AWG#22-#28	1.70mm(max)	Brass	Gold-plated	10,000pcs

Old Part No. : 2541-TGB-L

REV.	ECN NO. OR DESCRIPTION	REVISED	DATE

 糧德精密有限公司 Amtek Technology Co., Ltd. TEL: 886-2-2260-6878 FAX: 886-2-2260-8030	品名 TITLE	2.54mm TERMINAL			頁數 Page	1/1	
	品號 PART NO.	5T2541N-BG0RQ01			繪圖 DRAWN	Roy 2016/05/11	
	圖號 DRAWING NO.		版本 REV.	A	核對 CHECKED	Yvonne 2016/05/11	
	客戶品號 CUSTOMER P/N		比例 SCALE	None	承認 APPROVED	John 2016/05/11	
	公差 TOLERANCE	.X ± 0.25 .XX ± 0.20	.X°±3	單位 UNIT	mm	THIRD ANGLE PROJECTION	